

Date _____
Customer _____
Project _____
Type _____

LED Driver Constant Voltage 48V Non-Dim 150W

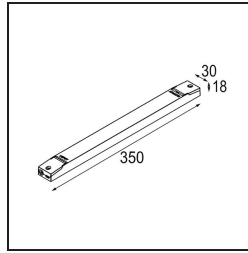
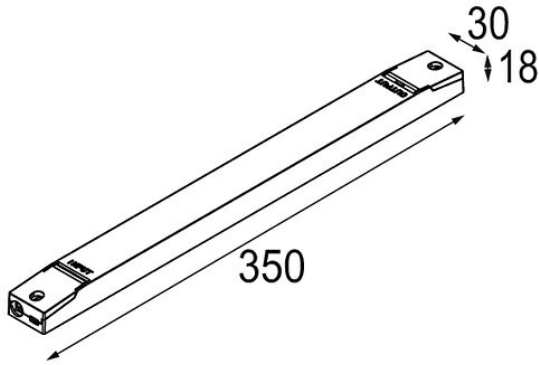

Specifications

Material	13550330
Lamp Included	No
Number of Light Sources	0
Electrical Class	II
IP Rating	20
Glow wire rating (°C)	960
Dimming Protocol	Non-Dim
Indoor/Outdoor	Indoor
Adjustability	Not Applicable
Gross weight (g)	263.0
Input voltage	220-240V AC / 50-60Hz
Ambient temperature	-25°C to +45°C
Power factor	0.92
Max. drivers on MCB 16A type B	8