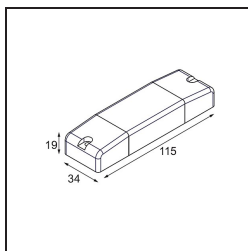
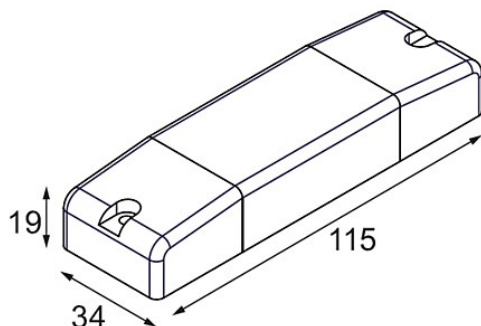

Datum

Klant

Project

Soort

LED Driver Constant Current Non-Dim 350mA 15W

Specificaties

Materiaal	13550130
Lamp inbegrepen	Neen
Aantal Lichtbronnen	0
Elektriciteitsklasse	II
IP-klasse	20
Gloeidraadtest (°C)	960
Protocol Voor Dimmen	Niet-Dimbaar
Binnen/Buiten	Binnen
Verstelbaarheid	Not Applicable
Brutogewicht (g)	60,0
Ingangsspanning	100-240V AC / 50-60Hz
Omgevingstemperatuur	-25°C to +45°C
Vermogensfactor	0,85
Driver past door inbouwopening(mm)	40,0
Dimmingtechnologie van driver	NON-DIM
Driver 2x LED-uitgang	Neen
Max. drivers on MCB 16A type B	27