

Date _____
Customer _____
Project _____
Type _____

LED Driver Constant Current Non-Dim 350mA 15W

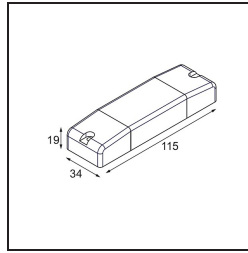
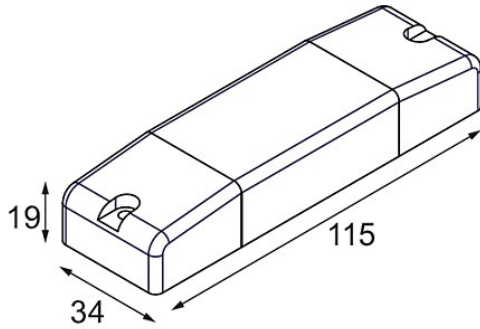

Specifications

Material	13550130
Lamp Included	No
Number of Light Sources	0
Electrical Class	II
IP Rating	20
Glow wire rating (°C)	960
Dimming Protocol	Non-Dim
Indoor/Outdoor	Indoor
Adjustability	Not Applicable
Gross weight (g)	60.0
Input voltage	100-240V AC / 50-60Hz
Ambient temperature	-25°C to +45°C
Power factor	0.85
Driver fits through cut-out hole (mm)	40.0
Driver dimming technology	NON-DIM
Driver 2x LED output	No
Max. drivers on MCB 16A type B	27