

LED Driver Constant Voltage 48V Surface (For Surface Mounting) 150W Black Structure

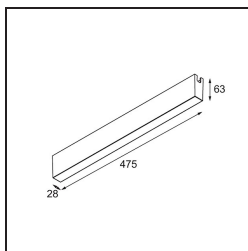
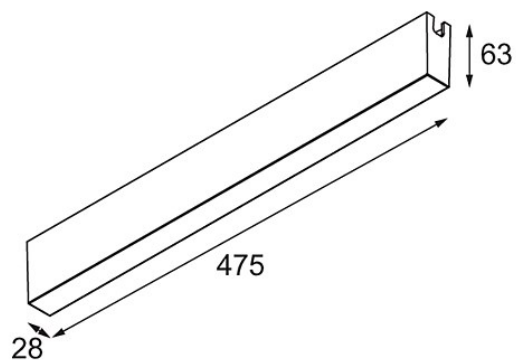

Specifications

Material	13418832
Lámpara Incluida	No
Número de fuentes de luz	0
Voltaje de entrada	230V
Clasificación eléctrica	I
Clasificación del IP	20
Clasificación de hilo incandescente (°C)	960
Interio/Exterior	Interior
Montaje	Superficie
Ajustabilidad	Not Applicable
Color principal & Acabado principal	Negro, Estructura
Peso bruto (g)	1190,0
Voltaje de entrada	220-240V AC / 50-60Hz
Temperatura ambiente	-25°C to +45°C
Factor de potencia	0,95
Max. drivers on MCB	8
16A type B	