

Date
Customer
Project
Type

Track 48V Connection 180° Electrical (For Surface Mounting) Black Structure

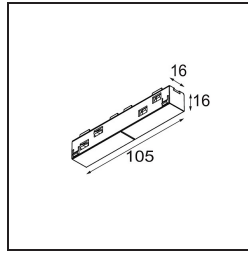
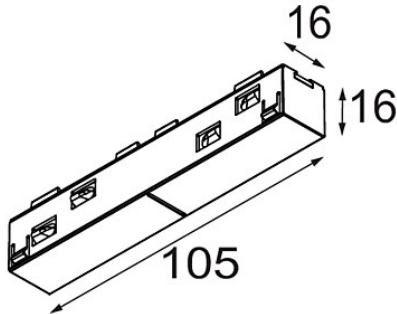

Specifications

Material	13411332
Lamp Included	No
Number of Light Sources	0
Input Voltage	48Vdc
Electrical Class	III
IP Rating	20
Glow wire rating (°C)	960
Indoor/Outdoor	Indoor
Adjustability	Not Applicable
Primary Colour & Primary Finish	Black, Structure
Gross weight (g)	42.0