

Datum

Klant

Project

Soort

LED Driver Constant Voltage 48V Non-Dim 320W

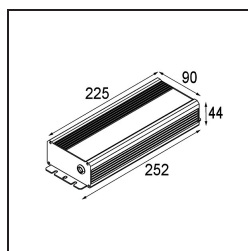
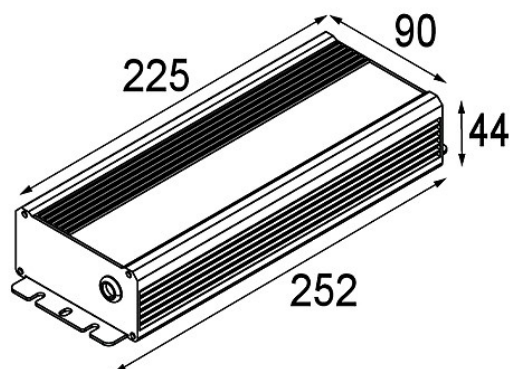

Specificaties

Materiaal	12409030
Lamp inbegrepen	Neen
Aantal Lichtbronnen	0
Elektriciteitsklasse	II
IP-klasse	20
Gloeidraadtest (°C)	960
Protocol Voor Dimmen	Niet-Dimbaar
Binnen/Buiten	Binnen
Verstelbaarheid	Not Applicable
Brutogewicht (g)	1771,0
Ingangsspanning	90-305V AC / 50-60Hz
Omgevingstemperatuur	-40°C to +90°C
Vermogensfactor	0,95
Max. drivers on MCB 16A type B	1