

*LED Driver Constant Voltage 48V Non-Dim 240W*

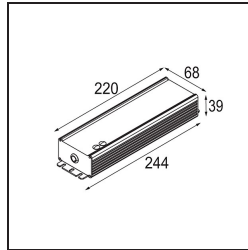
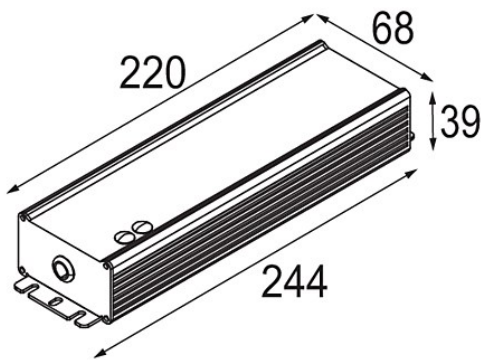

**Specifications**

Materiale	12408930
Lampadina inclusa	No
Numero di fonte luminosa	0
Classificazione elettrica	II
Grado IP	20
Test filo a caldo (°C)	960
Protocollo di regolazione (Dimmer)	non dimmerabile
Interno/Esterno	Interno
Orientabilità	Not Applicable
Peso lordo (g)	1135,0
Volt in ingresso	90-305V AC / 50-60Hz
Temperatura ambiente	-40°C to +90°C
Fattore di potenza	0,95
Max. drivers on MCB 16A type B	2