

Date \_\_\_\_\_  
Customer \_\_\_\_\_  
Project \_\_\_\_\_  
Type \_\_\_\_\_

*LED Driver Constant Voltage 48V Non-Dim 240W*

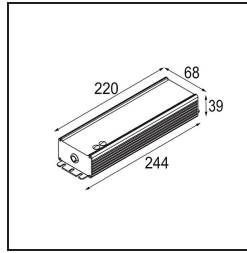
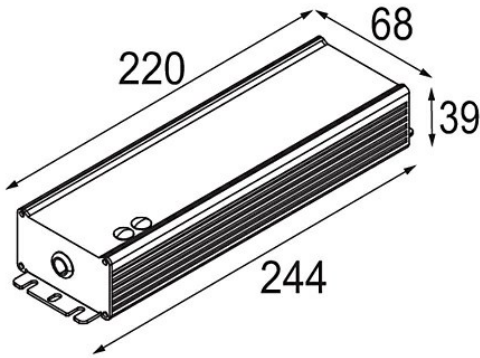

**Specifications**

Material	12408930
Lamp Included	No
Number of Light Sources	0
Electrical Class	II
IP Rating	20
Glow wire rating (°C)	960
Dimming Protocol	Non-Dim
Indoor/Outdoor	Indoor
Adjustability	Not Applicable
Gross weight (g)	1135.0
Input voltage	90-305V AC / 50-60Hz
Ambient temperature	-40°C to +90°C
Power factor	0.95
Max. drivers on MCB 16A type B	2