

Date \_\_\_\_\_  
Customer \_\_\_\_\_  
Project \_\_\_\_\_  
Type \_\_\_\_\_

*LED Driver Constant Current Trailing Edge 500mA 20W*

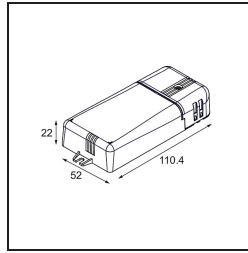
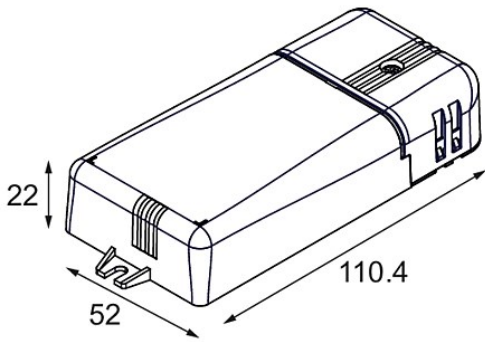

**Specifications**

Material	12404330
Lamp Included	No
Number of Light Sources	0
Electrical Class	II
IP Rating	20
Glow wire rating (°C)	960
Dimming Protocol	Trailing Edge
Indoor/Outdoor	Indoor
Adjustability	Not Applicable
Gross weight (g)	105.0
Input voltage	220-240V AC / 50-60Hz
Ambient temperature	-25°C to +45°C
Power factor	0.95
Driver fits through cut-out hole (mm)	55.0
Driver dimming technology	AM
Driver 2x LED output	No
Max. drivers on MCB 16A type B	50