

Date _____
Customer _____
Project _____
Type _____

Plaster Kit 240x287 - 145x56 1x

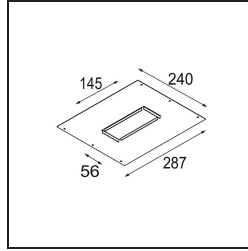
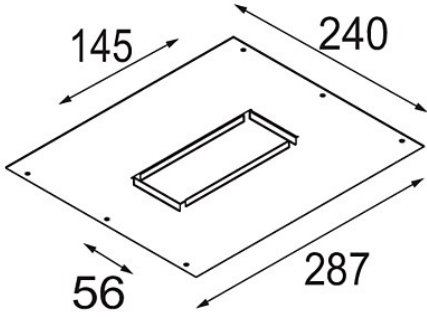

Specifications

Material	12291830
Lamp Included	No
Number of Light Sources	1
IP Rating	20
Glow wire rating (°C)	960
Indoor/Outdoor	Indoor
Application	Ceiling, Wall
Adjustability	Not Applicable
Gross weight (g)	560.0