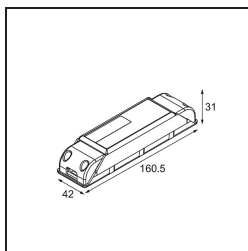
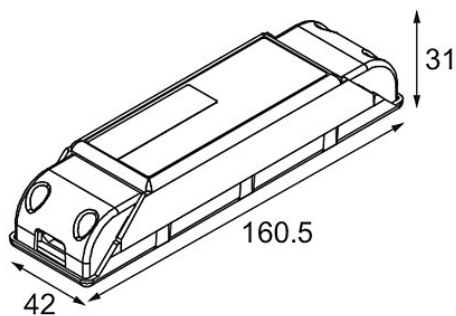

 Date

 Customer

 Project

 Type

LED Driver Constant Current Deep Dim 0-10V/1-10V 250mA 20W



Specifications

| | |
|---------------------------------------|-----------------------|
| Materiale | 11631330 |
| Lampadina inclusa | No |
| Numero di fonte luminosa | 0 |
| Classificazione elettrica | II |
| Grado IP | 20 |
| Test filo a caldo (°C) | 960 |
| Protocollo di regolazione (Dimmer) | 0-10V, 1-10V |
| Interno/Esterno | Interno |
| Orientabilità | Not Applicable |
| Peso lordo (g) | 125,0 |
| Volt in ingresso | 198-264V AC / 50-60Hz |
| Temperatura ambiente | -20°C to +50°C |
| Fattore di potenza | 0,8 |
| Driver adatto al foro di incasso (mm) | 54,0 |
| Tecnologia di dimmerazione del driver | AM |
| Driver uscita 2x LED | No |
| Max. drivers on MCB 16A type B | 106 |