

LED Driver Constant Current Deep Dim DALI 700mA 50W 2 LED Output WD

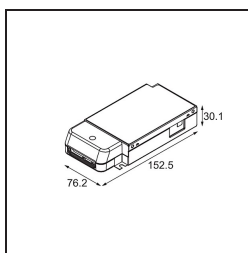
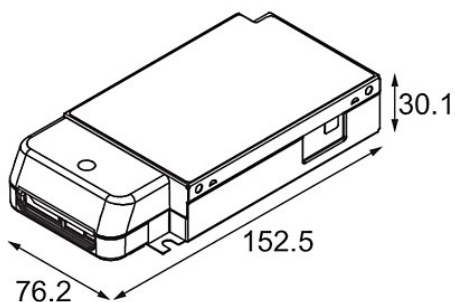

Specifications

Material	11630830
Lámpara Incluida	No
Número de fuentes de luz	0
Clasificación eléctrica	II
Clasificación del IP	20
Clasificación de hilo incandescente (°C)	960
Protocolo de regulación	DALI
DALI Standard	DALI-2
Interior/Exterior	Interior
Ajustabilidad	Not Applicable
Peso bruto (g)	293,0
Voltaje de entrada	120-255V AC / 50-60Hz
Temperatura ambiente	-20°C to +50°C
Factor de potencia	0,9
Driver apto para orificio de corte (mm)	84,0
Tecnología de regulación del driver	AM
Driver salida 2x LED	Sí
Max. drivers on MCB 16A type B	22
Remark	<ul style="list-style-type: none"> LED driver with 2 output channels, max. 55Vdc per channel