

*LED Driver Constant Current Deep Dim DALI 500mA 20W*

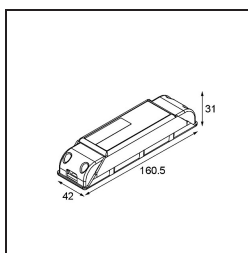
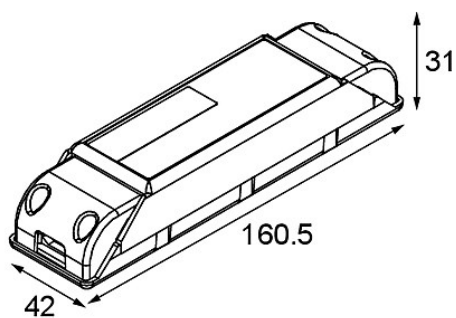

**Caractéristiques**

Matériaux	11630130
Ampoule incluse	Non
Nombre de Sources Lumineuses	0
Classe Électrique	II
Indice de protection IP	20
Essai au fil incandescent (°C)	960
Protocole de Variation	DALI
DALI Standard	DALI-2
Intérieur/extérieur	Intérieur
Ajustabilité	Not Applicable
Poids brut (g)	125,0
Tension d'entrée	198-264V AC / 50-60Hz
Température ambiante	-20°C to +50°C
Facteur de puissance	0,95
Driver adapté à l'ouverture de découpe (mm)	54,0
Technologie de gradation du driver	AM
Driver sortie 2x LED	Non
Drivers max. sur disjoncteur miniature 16 A type B	106