

Date \_\_\_\_\_  
Customer \_\_\_\_\_  
Project \_\_\_\_\_  
Type \_\_\_\_\_

*LED Driver Constant Current Deep Dim DALI 500mA 20W*

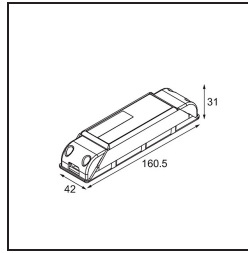
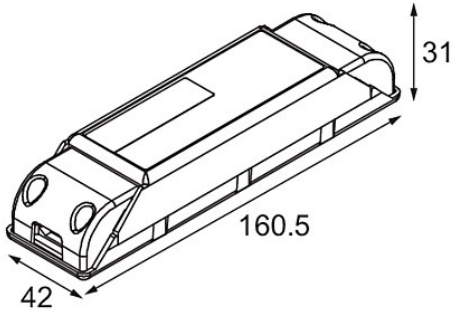

**Specifications**

Material	11630130
Lamp Included	No
Number of Light Sources	0
Electrical Class	II
IP Rating	20
Glow wire rating (°C)	960
Dimming Protocol	DALI
DALI Standard	DALI-2
Indoor/Outdoor	Indoor
Adjustability	Not Applicable
Gross weight (g)	125.0
Input voltage	198-264V AC / 50-60Hz
Ambient temperature	-20°C to +50°C
Power factor	0.95
Driver fits through cut-out hole (mm)	54.0
Driver dimming technology	AM
Driver 2x LED output	No
Max. drivers on MCB 16A type B	106