

Power Feed and Suspension Kit Round 5P Flat Moon (3) Triangle (Incl. Power Feed Cable & Suspension Cable 4000) White Structure

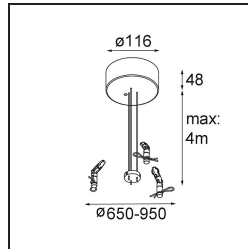
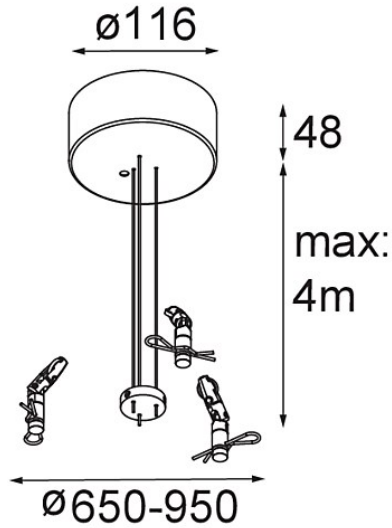

Specifications

Material	11066109
Lámpara Incluida	No
Número de fuentes de luz	0
Voltaje de entrada	230V
Clasificación eléctrica	I
Clasificación del IP	20
Clasificación de hilo incandescente (°C)	960
Interio/Exterior	Interior
Aplicación	Techo
Ajustabilidad	Not Applicable
Color principal & Acabado principal	Blanco, Estructura
Peso bruto (g)	1375,0