

Date \_\_\_\_\_  
Customer \_\_\_\_\_  
Project \_\_\_\_\_  
Type \_\_\_\_\_

*Installation Housing 192x190x130*

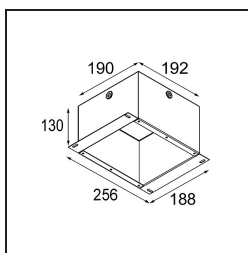
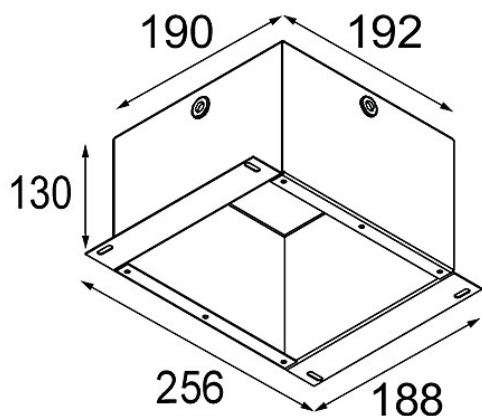

### Specifications

Materiale	10889830
Lampadina inclusa	No
Numero di fonte luminosa	0
Grado IP	20
Test filo a caldo (°C)	960
Interno/Esterno	Interno
Applicazione	Soffitto, Parete
Orientabilità	Not Applicable
Peso lordo (g)	1400,0