

Date _____
Customer _____
Project _____
Type _____

Installation Housing 192x190x130

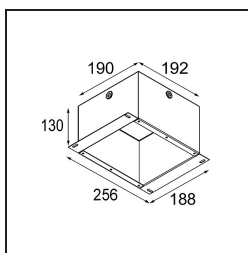
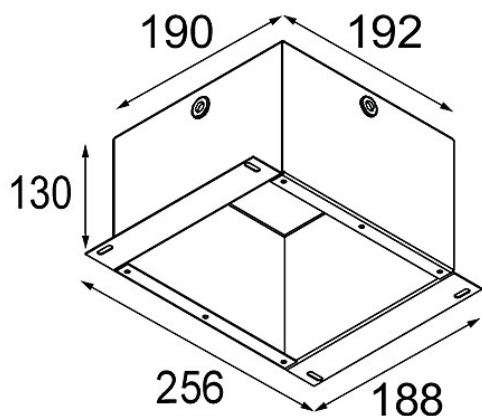

Specifications

Material	10889830
Lámpara Incluida	No
Número de fuentes de luz	0
Clasificación del IP	20
Clasificación de hilo incandescente (°C)	960
Interio/Exterior	Interior
Aplicación	Techo, Pared
Ajustabilidad	Not Applicable
Peso bruto (g)	1400,0