

Datum

Kunde

Projekt

Art

*Installation Housing 192x190x130*

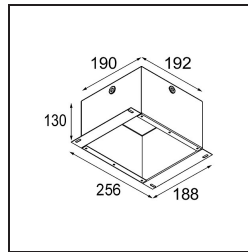
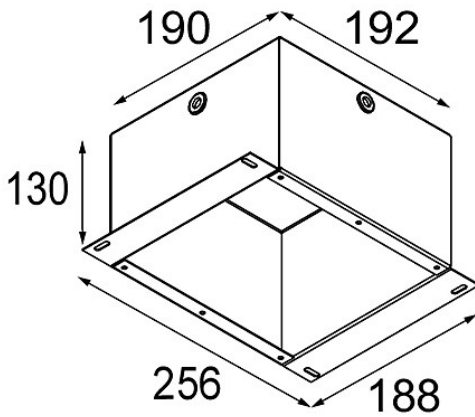

### Spezifikationen

Material	10889830
Leuchtmittel enthalten	Nein
Anzahl Lichtquellen	0
Schutzart	20
Glühdrahtprüfung (°C)	960
Innen/Außen	Innen
Anwendung	Decke, Wand
Verstellbarkeit	Not Applicable
Bruttogewicht (g)	1400,0