

Date _____
Customer _____
Project _____
Type _____

Plaster Kit Trimless 233x233 - 206x206 4x

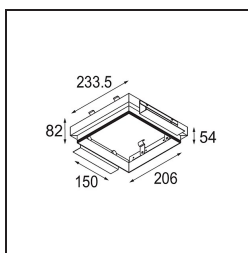
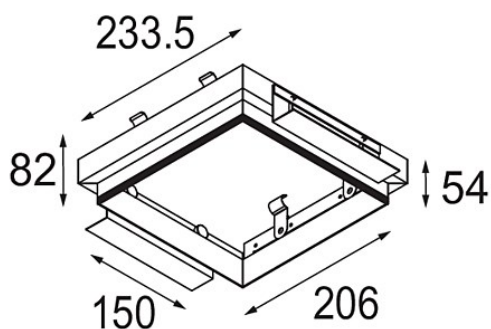

Specifications

Materiale	10460430
Lampadina inclusa	No
Numero di fonte luminosa	4
Grado IP	20
Test filo a caldo (°C)	960
Interno/Esterno	Interno
Applicazione	Soffitto, Parete
Orientabilità	Not Applicable
Peso lordo (g)	700,0