

Date _____
Customer _____
Project _____
Type _____

Plaster Kit Trimless 233x233 - 206x206 4x

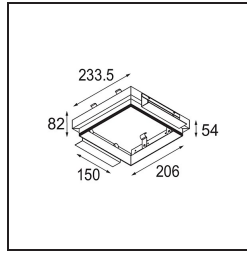
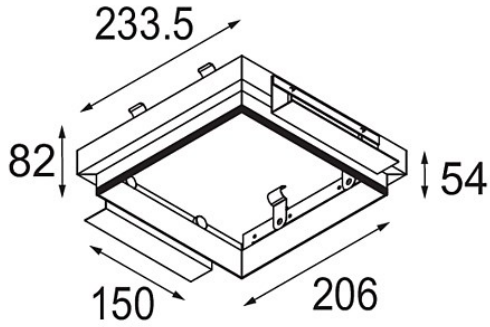

Specifications

Material	10460430
Lamp Included	No
Number of Light Sources	4
IP Rating	20
Glow wire rating (°C)	960
Indoor/Outdoor	Indoor
Application	Ceiling, Wall
Adjustability	Not Applicable
Gross weight (g)	700.0