

Date _____
Customer _____
Project _____
Type _____

Installation Housing 137x158x130

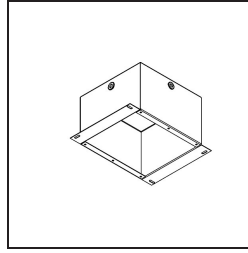
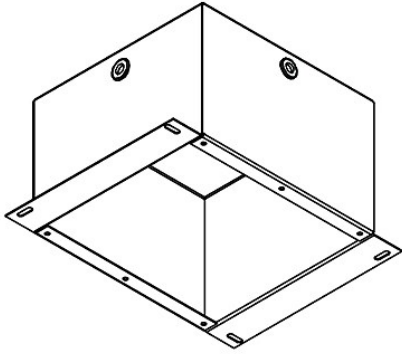

Specifications

Material	10440130
Lamp Included	No
Number of Light Sources	0
IP Rating	20
Glow wire rating (°C)	960
Indoor/Outdoor	Indoor
Application	Ceiling, Wall
Adjustability	Not Applicable
Gross weight (g)	1535.0