

Date _____
 Customer _____
 Project _____
 Type _____

Installation Housing 357x222x147

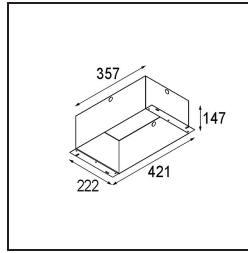
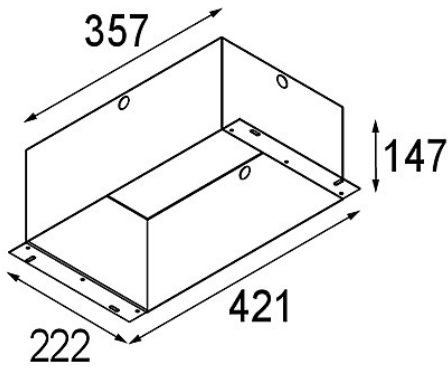

Specifications

Material	10400430
Lamp Included	No
Number of Light Sources	0
IP Rating	20
Glow wire rating (°C)	960
Indoor/Outdoor	Indoor
Application	Ceiling, Wall
Adjustability	Not Applicable
Gross weight (g)	2040.0