

Date \_\_\_\_\_  
Customer \_\_\_\_\_  
Project \_\_\_\_\_  
Type \_\_\_\_\_

*Installation Housing 257x327x147*

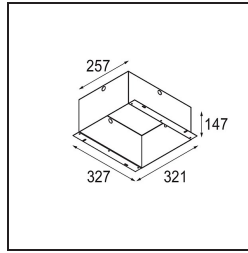
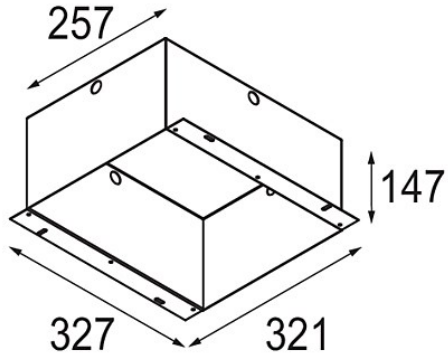

**Specifications**

Material	10400330
Lámpara Incluida	No
Número de fuentes de luz	0
Clasificación del IP	20
Clasificación de hilo incandescente (°C)	960
Interio/Exterior	Interior
Aplicación	Techo, Pared
Ajustabilidad	Not Applicable
Peso bruto (g)	2100,0