

Date _____
Customer _____
Project _____
Type _____

Installation Housing 257x222x147

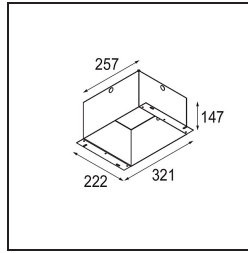
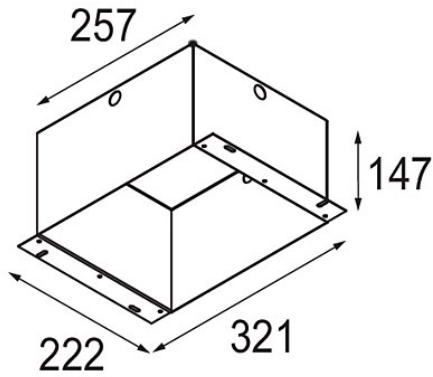

Specifications

Material	10400230
Lamp Included	No
Number of Light Sources	0
IP Rating	20
Glow wire rating (°C)	960
Indoor/Outdoor	Indoor
Application	Ceiling, Wall
Adjustability	Not Applicable
Gross weight (g)	2010.0