

Date _____
Customer _____
Project _____
Type _____

Installation Housing 122x257x147

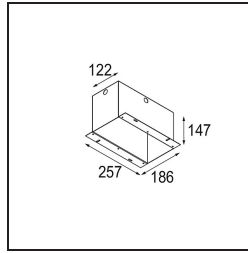
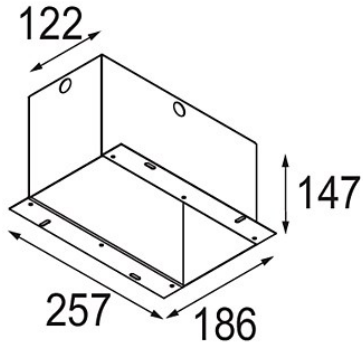

Specifications

| | |
|-------------------------|----------------|
| Material | 10400130 |
| Lamp Included | No |
| Number of Light Sources | 0 |
| IP Rating | 20 |
| Glow wire rating (°C) | 960 |
| Indoor/Outdoor | Indoor |
| Application | Ceiling, Wall |
| Adjustability | Not Applicable |
| Gross weight (g) | 1450.0 |